

# Sheepie®

explore like never before



## **YUNA ROOFTOP TENT** **USER MANUAL**



### **READ ME FIRST!**

*Thank you for purchasing a Sheepie rooftop tent. Before you start using this rooftop tent, we strongly advise you to read this manual carefully. We hope you enjoy your rooftop tent! Become part of our passion and explore like never before.*



### **IMPORTANT WARNING!**

*It is critical that all Sheepie products are assembled properly and securely assembled to your vehicle. Improper attachment could result in an automobile accident and could cause serious injury or death.*

[www.Sheepie.com](http://www.Sheepie.com)



# Table of contents

## Instruction

1. Product instruction - <b>Introduction</b> .....	4
2. Product instruction - <b>Overview of elements</b> .....	5
3. Product installation - <b>An easy installation</b> .....	6
4. Setting up - <b>A fast and easy set up</b> .....	8
5. Folding down - <b>Securely folding down</b> .....	10

## Important information

6. Safety - <b>Important information for your own safety</b> .....	12
7. Safety - <b>Usage and Cautions</b> .....	13
8. <b>Disclaimer</b> .....	15

# 1.

## Product instruction

Introduction

### Sheepie Yuna rooftop tent Setup Guide

Congratulations on your purchase of the Sheepie Yuna rooftop tent! This guide will provide step-by-step instructions to help you set up your tent and make the most of your outdoor adventures. Before you begin, ensure you have all the necessary components and follow safety precautions for a smooth setup process.

#### Safety Precautions:

1. Always set up the Sheepie Yuna rooftop tent on a level and stable surface.
2. Avoid areas with overhanging branches or sharp objects that could damage the tent.
3. Check the weather conditions before setup. Avoid setting up the tent during strong winds or storms.

#### Package Contents:

The Sheepie Yuna rooftop tent package should include the following:

1. Rooftop tent body with attached base and ladder
2. Mounting brackets and hardware (as shown on page 5)

#### Required:

1. Cross bars or roof rack
2. Step-by-Step setup
3. At least 2 persons for installation

# 2.

## Product instruction

An overview of all installation elements

### INCLUDED

1	4x	U shape Stator
2	8x	M8 flat Washer
3	8x	M8 Arc Washer
4	8x	Plastic Nut
5	8x	T shape Bolts

**i** Placed inside one of the shoebags

### NEEDED



2 persons needed for installation

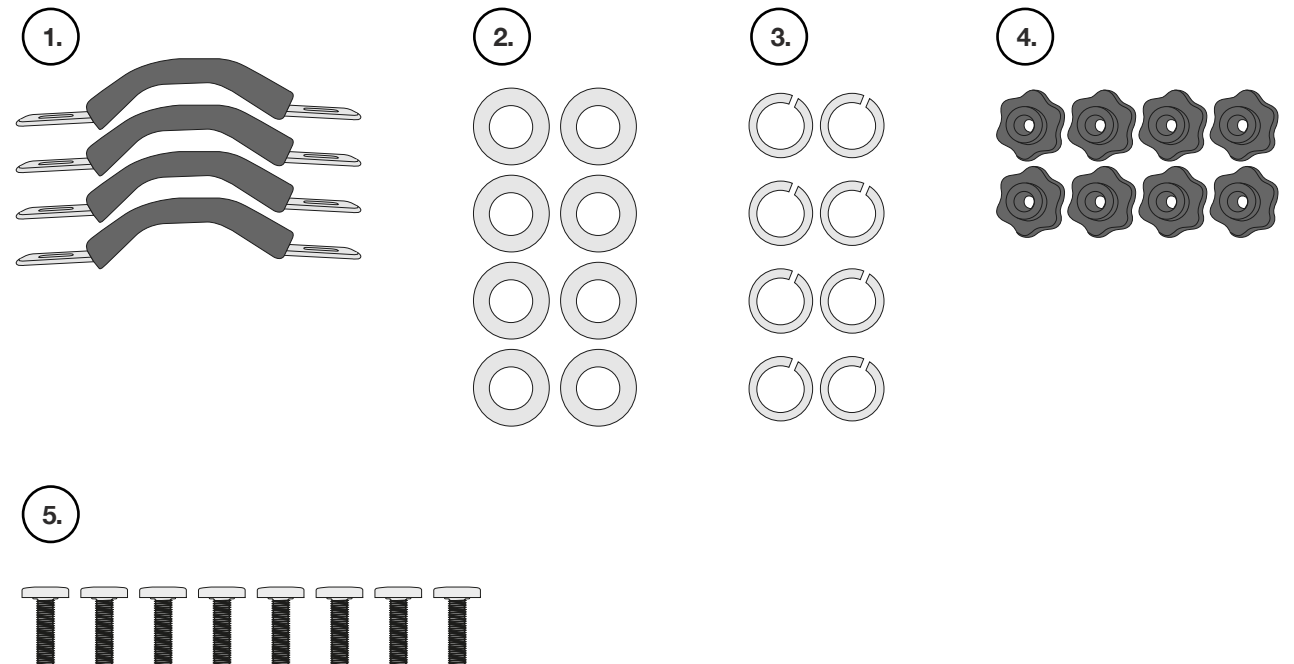

# 3.

## Product installation

An easy installation



2 persons installation

**!** Note: The following instructions assume that you have already installed the appropriate roof rack or crossbars in the load bearing position on your vehicle.

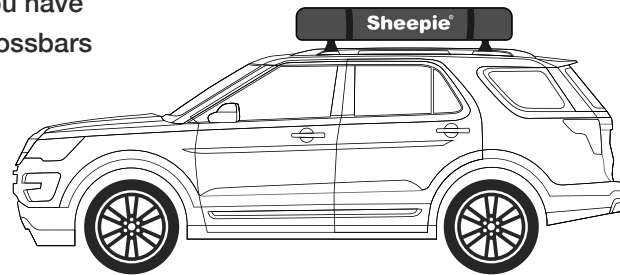

### Step 1: Lift up

Lift the tent onto the rack from the side of your vehicle (2 persons). Adjust the tent to be in the centre of the roof, ensuring the rear door can be opened/closed.

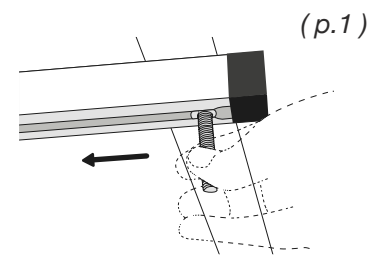

### Step 2: Slide bolts (shown in p.1)

Slide the T-shape bolts into the rails from both sides.

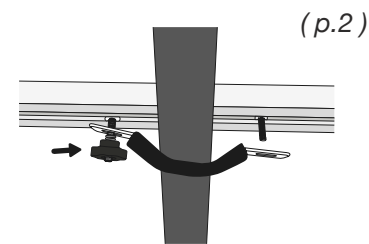

### Step 3: Positioning (4x) (shown in p.2)

1. Slide the T shape bolts into the middle hole of the rail
2. Place the U shape stator, m8 flat washer, m8 washer and plastic Nut
3. Screw lightly in advance
4. Screw the other side of U shape stator (repeat step 3.2)

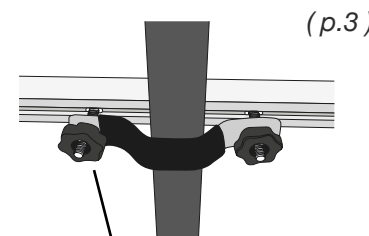

### Step 4: Fasten (shown in p.3)

1. Make sure the tent is centered on your vehicle's roof and properly aligned with the mounting brackets.
2. Firmly tighten the bolts on each stator.
3. Once the tent is mounted, check its stability. Gently shake the tent to ensure it is securely attached to the roof rack.

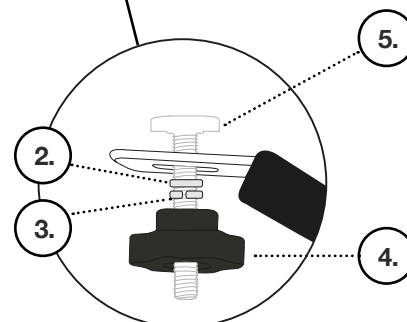

# 4.

## Setting up

A fast and easy set up



G'day, mates! Ready to rooftop like a true Aussie? Hop on over to our top-notch website [www.sheepie.com](http://www.sheepie.com), or youtube channel [@SheepieProducts](https://www.youtube.com/@SheepieProducts) for a setup video!

## Setting up

A fast and easy set up

### Step 1: Choose a Suitable Location

Choose a safe and level surface to park your vehicle before setting up the tent. Ensure there is enough space around the vehicle to extend the ladder and open the tent without obstructions.

### Step 2: Release cover

1. Undo any straps or locks securing the tent's cover in place.
2. Gently push the tent's cover upward to unfold it.
3. Remove the cover.
4. Undo the velcro straps securing the tent's frame.



### Step 3: Extend the Ladder

1. Remove the velcro strap attaching the ladder to the frame.
2. Pull the ladder gently until it is fully extended.

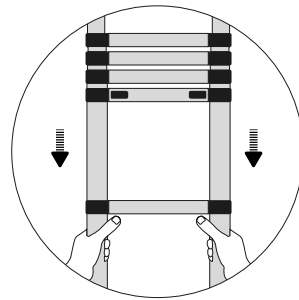

### Step 4: Opening the Tent

1. Hold the bottom of the ladder and use it as a lever to push down and open the tent.
2. Adjust the length of the ladder to the right size. *(We recommend adjusting the ladder in such a way that each required step is fully extended.)*
3. Make sure each rung of the ladder is locked in place.
4. Add the support poles to the outer left and right corners *(if delivered with your tent).*

*Note: The tent model in the manual may differ from the image.*

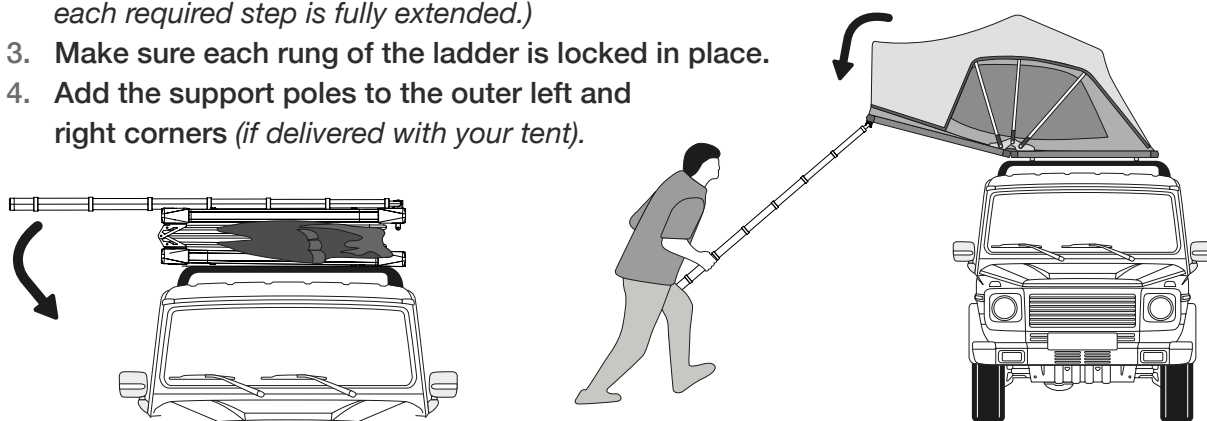

## Setting up

A fast and easy set up

### Step 5: Canopy setup

1. Press the pins on both sides of the telescopic pole.
2. Fully extend the telescopic pole.
3. Slide out the canopy.
4. Place the separate, extendable rod in the top center and extend it to firmly tension the canopy.

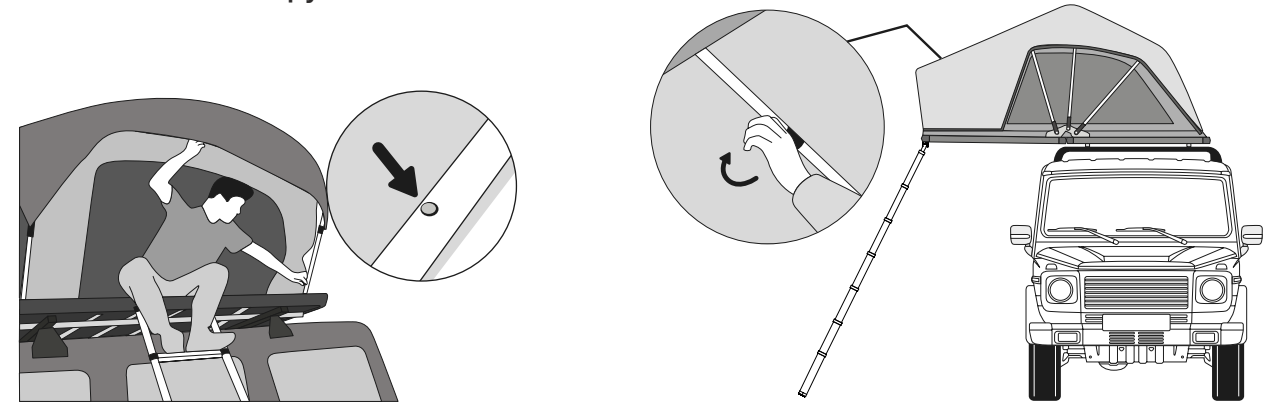

*Note: The tent model in the manual may differ from the image.*

### Step 6: Interior Setup

1. Climb up the ladder to access the tent's interior.
2. Unzip the tent entrance and open it fully.

### Step 7: Final Checks

1. Double-check all connections to ensure they are properly fastened and secured.
2. Confirm that the ladder is stable and firmly placed on the ground.

Congratulations! Your Sheepie Yuna rooftop tent is now set up and ready for use. Enjoy your camping adventures and have a wonderful time in the great outdoors!

## Folding down

Securely folding down your rooftop tent

### Step 1: Preparations

1. Hook the elastic ropes (if provided) inside the tent (shown in p.1.).
2. Close all windows (Make sure the zippers are at the top of the window when it is closed)
3. Zip up the entrance to a two-thirds position or less.  
(Do not close the entrance completely when folding down the rooftop tent).

### Step 2: Preparation for folding

1. Shorten and remove the extendable rod
2. Press the button on two sides of canopy to shorten the front door telescopic pole (shown in p.2.)
3. Tuck the shoe bags in (shown in p.3.).

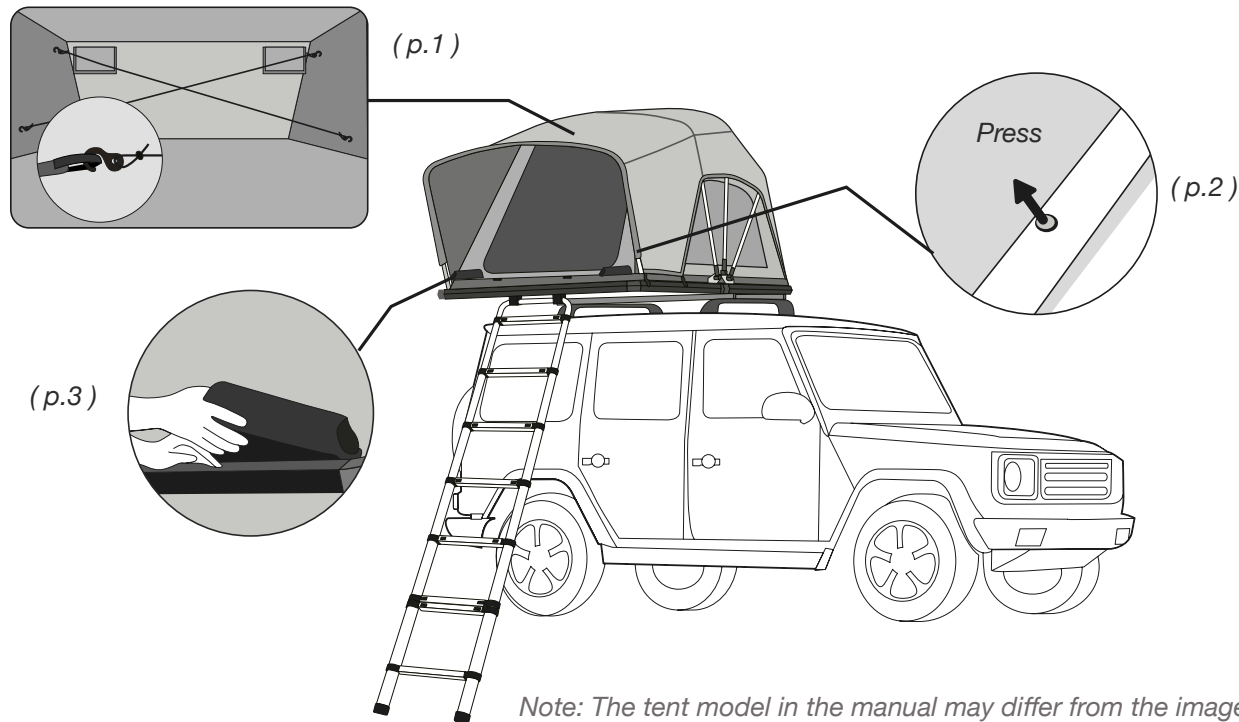

**Note:**  
Ensure that the rooftop tent is always dry when folded. If the tent is folded while wet, it must be reopened within 24 hours for drying.

## Folding down

Securely folding down your rooftop tent

### Step 3: Folding the rooftop tent

Make sure the tent is neatly folded and no fabric is sticking out. Press the two buttons on the bottom rung of the ladder and push forward to shorten the ladder

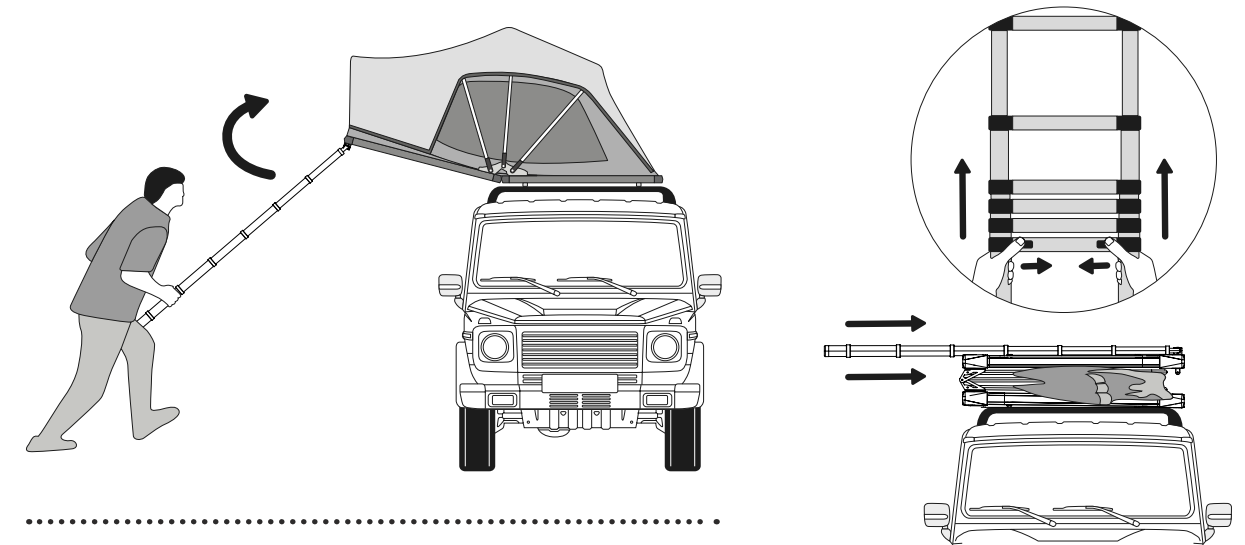

### Step 4: Secure the tent

1. Secure the velcro straps of the tent.
2. Put the cover on.
3. Fasten all the buckles around the cover.

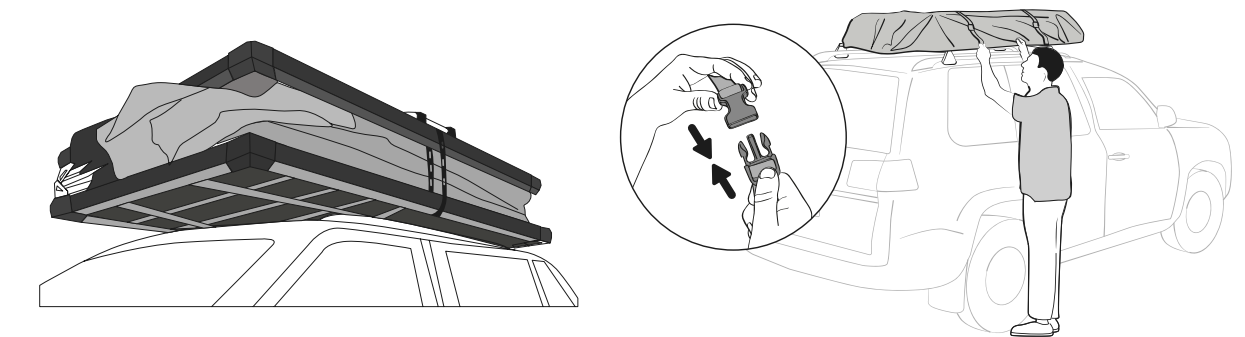

Note: The tent model in the manual may differ from the image.

### Step 5: Final Checks

1. Double-check all connections to ensure they are properly fastened and secured.
2. Confirm that the rooftop tent is stable.



## Safety

Important information for your own safety

The fabric of this tent is not fireproof. The material can catch fire when it directly comes in contact with flames.

 Do NOT use matches, candles or open flames in or near your rooftop tent under any circumstances.

Also, you should NOT:  
Cook inside the tent; make a campfire near your rooftop tent; smoke inside the tent; use fuel-powered heaters, stoves or lanterns in your rooftop tent; store inflammable liquids inside the tent.

 **Weight Limit:** Do not use the tent with more persons than it is intended for. Overloading the tent can compromise its structural integrity, leading to accidents or damage. For the Sheepie Yuna rooftop tent, the maximum amount of persons per model is: 2 persons for the Yuna 140, 3 persons for the Yuna 160, and 2 adults + 2 children for the Yuna Family.

 **Securing the Ladder:** Place the ladder firmly on the ground at an angle of about 70 degrees. Ensure that the ladder is securely attached to the tent and the ground. Double-check the ladder locking mechanisms before climbing up or down. The ladder (and the 2 frame supporting poles, if delivered with your model) is a support for the rooftop tent's base plate and should therefore not be removed when there is a person or animal in it.

 **Caution with Children:** Do not allow unsupervised children to play around or in the rooftop tent. Climbing the ladder or moving inside the tent without proper supervision can be hazardous.

 **Proper Use of Zippers:** Use the tent's zippers carefully to prevent jamming or damage. Avoid forcing the zippers and make sure they are free from debris or obstructions.

 **Traveling with the Tent:** Be cautious of overhead obstacles and clearance heights while traveling with the rooftop tent on your vehicle. Avoid low-clearance areas and obstacles. Stay safe on the road and be vigilant about overhead clearance.

Remember, safe usage of the Sheepie rooftop tent is essential for a pleasant camping experience. If you have any questions or concerns regarding the safety or use of the tent, please don't hesitate to contact our customer support team.

Adventure responsibly and have a fantastic time exploring the outdoors with your Sheepie rooftop tent!

## Safety

Usage and Cautions

Before using the Sheepie rooftop tent, please read and understand this user manual carefully. Always prioritize safety and follow the instructions provided. Failure to do so may result in damage to the tent or cause accidents that could lead to serious injury.

### 1. Inspect the Tent Regularly:

To ensure the Sheepie rooftop tent is in good condition and safe to use, inspect it regularly. Check for signs of wear, tear, or any damage to the fabric, zippers, poles, and straps. If you find any issues, do not use the tent until they are repaired or replaced.

### 2. Proper Installation:

Always follow the manufacturer's guidelines for installing the tent on your vehicle. Incorrect installation may lead to accidents or death. Make sure all straps, buckles, and mounts are securely fastened and tightened.

We strongly advise keeping the distance between your car load bars (front to rear bar) between 70-110cm and to make sure that the rooftop tent is centred as much as possible.

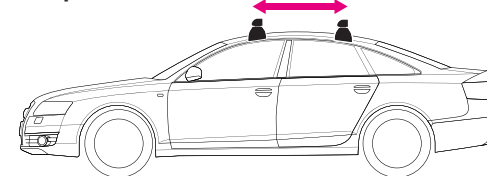

We advise making sure that your rooftop tent does not extend more than 60 cm from the front crossbar. A minimum of 80cm (size B) of clearance is required for

installation of the rooftop tent. You should always check if both load bars reach this size (for most vehicles it does). Sheepie offers optional adapter kits in case your vehicle does not reach this size. For installations on roof racks, often used on 4WD vehicles, consult your Sheepie dealer.

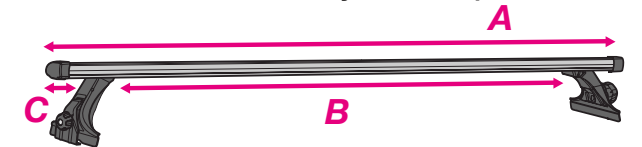

### 3. Weight Limit:

Do not exceed the maximum load capacity of your vehicle and your crossbars/roof rack. Always follow the instructions provided by the manufacturer of your vehicle and your crossbars/roof rack.

### 4. Product Weight Specifications:

Sheepie® Yuna 2.0 net weight incl. ladder:  
Yuna 140 = 65 kg  
Yuna 160 = 69 kg  
Yuna Family = 75 kg

### 5. Securing Your Gear:

Properly secure all your gear inside the tent while traveling to prevent items from shifting and damaging the tent fabric during transit.

### 6. Driving Precautions:

While driving with the Sheepie rooftop tent mounted on your vehicle, observe the following precautions:

- Do not exceed the recommended speed limits while carrying the tent. We recommend not to drive faster than

## Safety

### Usage and Cautions

120km/h with a rooftop tent. Exceeding this speed can result in accidents, damage to your vehicle and rooftop tent.

- b. Avoid low clearance areas or driving under obstacles that may hit the tent.
- c. Drive carefully in adverse weather conditions (high winds, heavy rain, etc.), as they may affect the stability of the tent. Keep in mind that your car's total height is higher with a rooftop tent and that the handling of your car can be different (sidewind sensitivity, behaviour in corners and when braking, etc.).
- d. Check every time before you drive, and regularly throughout your trip, if your rooftop tent is still securely attached to your roof racks. This also applies to your roof racks themselves.

#### **7. Be Cautious During Setup:**

When setting up the tent, be cautious of your surroundings. Avoid locations with overhanging branches, sharp rocks, or uneven surfaces that may puncture the fabric or damage the tent structure.

#### **8. Handling Poles and Mechanisms:**

Be gentle when extending or collapsing the tent poles and mechanisms. Rough handling can cause them to bend or break, leading to potential accidents and damage to the tent.

#### **9. Caution in Extreme Weather:**

In severe weather conditions such as strong winds, storms, or heavy snow, avoid using the tent. Extreme weather can damage the tent and compromise your safety.

#### **10. Watch for Insects and Wildlife:**

Before entering the tent or closing it up, check for insects or wildlife that may have crawled inside. Creatures like insects, snakes, or small animals can cause damage or be dangerous if trapped inside.

#### **11. Adequate Maintenance:**

Regularly clean the tent. Keep the tent dry and store it properly when not in use to prevent mold, mildew, and other potential damages.

#### **12. Insurance and Coverage:**

Consider insuring your Sheepie rooftop tent or checking if your existing vehicle insurance covers any damages or accidents related to the tent. This may provide peace of mind and financial protection in case of unexpected incidents.

#### **13. Contact the Manufacturer:**

If you experience any issues with the Sheepie rooftop tent or have questions about its use and maintenance, contact the manufacturer for assistance or visit their website for support.

By following these guidelines and prioritizing safety, you can ensure a long-lasting and enjoyable experience with your Sheepie rooftop tent while minimizing the risk of accidents and damage.

## Disclaimer

### Manufacturer's Liability Waiver

The manufacturer of the Sheepie rooftop tent hereby states that the use of the product is entirely at the user's own risk. By using the Sheepie rooftop tent, you acknowledge and agree to the terms and conditions of this liability waiver.

#### **1. Assumption of Risk:**

You understand and accept that camping and outdoor activities involve inherent risks, including but not limited to accidents, injuries, and property damage. The Sheepie rooftop tent is designed for use on vehicles and while every effort has been made to ensure its safety and reliability, there are inherent risks associated with its usage.

#### **2. Proper Use:**

It is the user's responsibility to use the Sheepie rooftop tent in accordance with the manufacturer's guidelines, user manual, and safety instructions. Failure to do so may result in accidents, damage to the tent, or personal injuries.

#### **3. Proper Installation:**

The user agrees to strictly follow the installation instructions provided in the Sheepie rooftop tent installation guide. Failure to properly install the tent may result in accidents or damage. The user is solely responsible for ensuring the correct and secure installation of the rooftop tent.

#### **4. Vehicle Suitability:**

The user is solely responsible for ensuring that their vehicle is suitable for mounting and carrying the Sheepie rooftop tent. It is essential to follow the recommended weight limits and installation procedures provided by the manufacturer of your vehicle and your crossbars/roofrack.

#### **5. Misuse and Overloading:**

The user shall not misuse the Sheepie rooftop tent or overload it beyond its maximum recommended capacity. Any misuse or overloading may result in accidents, product damage, or voiding of warranty.

#### **6. Inspection and Maintenance:**

The user agrees to regularly inspect and maintain the Sheepie rooftop tent according to the maintenance guidelines provided in the installation guide. Negligence in maintaining the tent may lead to malfunctions, accidents, or product failure. Regularly inspect the Sheepie rooftop tent for any signs of wear, damage, or defects.

#### **7. Extreme Weather Conditions:**

Avoid using the Sheepie rooftop tent in extreme weather conditions, such as strong winds, storms, heavy snow, or any other hazardous weather. Extreme weather can cause damage to the tent and compromise its stability.



## Disclaimer

### Manufacturer's Liability Waiver

#### 8. Disclaimer of Liability:

The manufacturer of the Sheepie rooftop tent shall not be held liable for any accidents, injuries, damages, or losses resulting from the use of the product. This includes but is not limited to direct, indirect, incidental, or consequential damages.

#### 9. Indemnification:

The user agrees to indemnify and hold the manufacturer harmless from any claims, damages, liabilities, or expenses (including attorney fees) arising from the user's installation, use, or misuse of the Sheepie rooftop tent.

#### 10. Modification and Alterations:

Modifying or altering the Sheepie rooftop tent in any way may compromise its safety and void any warranties or guarantees. The manufacturer shall not be held responsible for any damages or injuries resulting from modifications made to the product.

#### 11. Insurance Coverage:

It is recommended that users check their vehicle insurance policy or consider separate coverage for the Sheepie rooftop tent to protect against potential damages or accidents.

#### 12. Contact the Manufacturer:

If you have any questions or concerns about the Sheepie rooftop tent or its usage, please contact the manufacturer for support and assistance.

By proceeding with the installation of the Sheepie rooftop tent, the user acknowledges that they have read, understood, and accepted the terms and conditions of this liability waiver. If the user does not agree with any part of this waiver, they must refrain from installing the Sheepie rooftop tent and should contact the manufacturer for further assistance.

Always prioritize safety and exercise caution while using the tent to ensure a safe and enjoyable outdoor experience.

#### 13. Legal Disclaimer

Errors and changes reserved.

Although the utmost care has been taken with this manual, errors and omissions cannot be entirely excluded.

Sheepie Products B.V. therefore accepts no liability, not even for direct or indirect damage, occurring due to or in relation with the use of the content of this publication.

Sheepie Products B.V. | EU Importer | The Netherlands  
Chamber of Commerce 74500643 | [contact@sheepie.com](mailto:contact@sheepie.com)



**Sheepie**<sup>®</sup>  
explore like never before

[www.Sheepie.com](http://www.Sheepie.com)